



Mallory Sonalert Products, Inc.

Part #:

SC628MAH

Sales Outline Drawing

Revision:

D

Specifications:

MILITARY UNIT

Sound Level Category	Medium
Mode of Operation	Continuous
Voltage Rating	6 to 28 VAC/DC
Frequency	4500 ± 500 Hz
Loudness @ Min Vdc	68 dB(A) @ 2 Feet and 6 Vdc
Loudness @ Max Vdc	80 dB(A) @ 2 Feet and 28 Vdc
Current Draw	4-16mA
Housing Material	6/6 Nylon, Color: Black
Storage Temperature	-65° to +85° C
Operating Temperature	-40° to +85° C
Panel Mounting	Recommended hole size is 1.25"(31.75mm). Thread front will fit standard 30mm(1.181") hole.
Knurled Nut	Used to attach part to panel. The max recommended torque is 10 in-lbs.
Weight (Typical)	2.1 oz (60g)
NEMA 3R,4X, & 12	Approved with use of ACC03.
Options	Please contact factory.

Dimensions: Inches (mm)

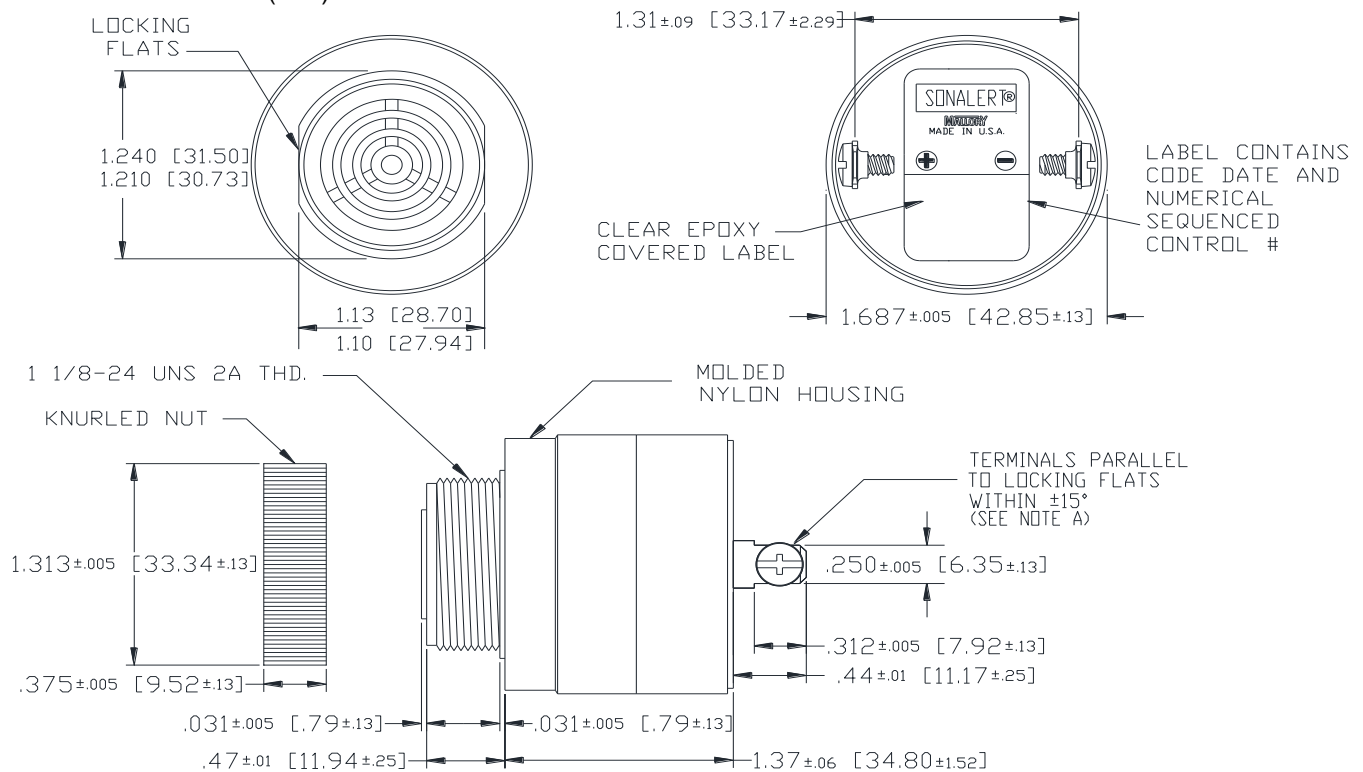

NOTE A: TERMINALS-.032 BRASS TIN PLATED, TAPPED FOR #6-32 SCREW. TWO #6-32 NICKEL PLATED BRASS SCREWS INCLUDED. WILL ACCEPT 1/4" QUICK CONNECT.

NOTE B: MOUNTING- REMOVE KNURLED NUT AND INSERT THREADED FRONT THROUGH 1.25" HOLE PUNCHED IN PANEL, IF ORIENTATION IS NEEDED, NOTE LOCKING FLATS ON DRAWING. SCREW NUT BACK ON. DO NOT OVERTIGHTEN.